

**FLUKE®**

# **51 & 52 Series II**

Thermometer

Users Manual

English

September 1999 Rev.2, 11/10

© 1999-2010 Fluke Corporation, All rights reserved.

All product names are trademarks of their respective companies. Specifications subject to change without notice

### **Limited Warranty & Limitation of Liability**

This Fluke product will be free from defects in material and workmanship for 3 years from the date of purchase. This warranty does not cover fuses, disposable batteries or damage from accident, neglect, misuse or abnormal conditions of operation or handling. Resellers are not authorized to extend any other warranty on Fluke's behalf. To obtain service during the warranty period, send your defective tester to the nearest Fluke Authorized Service Center with a description of the problem.

THIS WARRANTY IS YOUR ONLY REMEDY. NO OTHER WARRANTIES, SUCH AS FITNESS FOR A PARTICULAR PURPOSE, ARE EXPRESSED OR IMPLIED. FLUKE IS NOT LIABLE FOR ANY SPECIAL, INDIRECT, INCIDENTAL OR CONSEQUENTIAL DAMAGES OR LOSSES, ARISING FROM ANY CAUSE OR THEORY. Since some states or countries do not allow the exclusion or limitation of an implied warranty or of incidental or consequential damages, this limitation of liability may not apply to you.

Fluke Corporation  
P.O. Box 9090  
Everett WA  
98206-9090

Fluke Europe B.V.  
P.O. Box 1186  
5602 B.D. Eindhoven  
The Netherlands

To register your product, visit [www.fluke-warranty.com](http://www.fluke-warranty.com)

# Table of Contents

Title	Page
Introduction .....	1
Contacting Fluke.....	1
Getting Started .....	4
Components .....	5
Display Elements.....	6
Buttons .....	7
Using the Thermometer.....	9
Changing Setup Options .....	9
Entering or Exiting Setup.....	9
Setup Options.....	9
Changing a Setup Option .....	10
Measuring Temperatures .....	11
Connecting a Thermocouple.....	11
Displaying Temperatures.....	11
Holding the Displayed Readings.....	12
Viewing the MIN, MAX, and AVG Readings .....	12
Using the Offset to Adjust for Probe Errors .....	12

Maintenance .....	13
Replacing the Batteries .....	13
Cleaning the Case and Holster .....	13
Calibration .....	13
Specifications.....	13
Environmental .....	13
General .....	14
80 PK-1 Thermocouple (supplied with thermometer) .....	14
Electrical .....	14
Replacement Parts and Accessories .....	15

# 51 & 52 Series II

## Introduction

The Fluke Model 51 and Model 52 Thermometers (“the thermometer”) are microprocessor-based, digital thermometers designed to use external J-, K-, T-, and E-type thermocouples (temperature probes) as temperature sensors.

Use the thermometer only as specified in this manual. Otherwise, the protection provided by the meter may be impaired.

Refer to safety information in Table 1 and meter symbols in Table 2.

## Contacting Fluke

To order accessories, receive assistance, or locate the nearest Fluke distributor or Service Center, call:

1-888-99-FLUKE (1-888-993-5853) in USA  
1-800-36-FLUKE (1-800-363-5853) in Canada  
+31-402-678-200 in Europe  
+81-3-3434-0181 in Japan  
+65-738-5655 in Singapore  
+1-425-446-5500 from other countries

Address correspondence to:

Fluke Corporation	Fluke Europe B.V.
P.O. Box 9090	P.O. Box 1186
Everett, WA 98206-9090	5602 BD Eindhoven
USA	The Netherlands

Visit us on the World Wide Web at: [www.fluke.com](http://www.fluke.com).

To register your product, visit <http://register.fluke.com>.

**Table 1. Safety Information**

** Warning**

**A Warning identifies conditions and actions that pose hazards to the user. To avoid electrical shock or personal injury, follow these guidelines:**

- **Before using the thermometer inspect the case. Do not use the thermometer if it appears damaged. Look for cracks or missing plastic. Pay particular attention to the insulation around the connectors.**
- **Disconnect the thermocouple(s) from the thermometer before opening the case.**
- **Replace the batteries as soon as the battery indicator (🔋) appears. The possibility of false readings can lead to personal injury.**
- **Do not use the thermometer if it operates abnormally. Protection may be impaired. When in doubt, have the thermometer serviced.**
- **Reflective objects result in lower than actual temperature measurements. These objects pose a burn hazard.**
- **Do not operate the thermometer around explosive gas, vapor, or dust.**
- **Do not connect to voltages > 30 V ac rms, 42 V pk, 60 V dc from earth ground.**

Table 1. Safety Information (cont.)

**⚠ Warning (cont.)**





- **Model 52:** Measurement errors may occur if voltages on the measurement surfaces result in potentials greater than 1 V between the two thermocouples. When potential differences are anticipated between the thermocouples, use electrically insulated thermocouples.
- When servicing the thermometer, use only specified replacement parts.
- Do not use the thermometer with any part of the case or cover removed.

**Caution**

**A Caution identifies conditions and actions that may damage the meter or the equipment under test.**

- Use the proper thermocouples, function, and range for your thermometer.
- Do not attempt to recharge the batteries.
- To prevent explosion, do not throw batteries into a fire.
- Follow local laws or regulations when disposing of batteries.
- Match the + and – polarities of the battery with the battery case.

**Table 2. International Symbols**

	Refer to the manual for information about this feature.		Complies with European Union directives.
	Battery.		Complies with relevant Canadian Standards Association directives.

## **Getting Started**

Everything in this *Users Manual* applies both to Models 51 and 52 unless otherwise indicated.

To become familiar with the thermometer, study the following:

- Figure 1 and Table 3 describe the components.
- Figure 2 and Table 4 describe the display.
- Table 5 describes the functions of the buttons.

Then read the following sections.



## Components

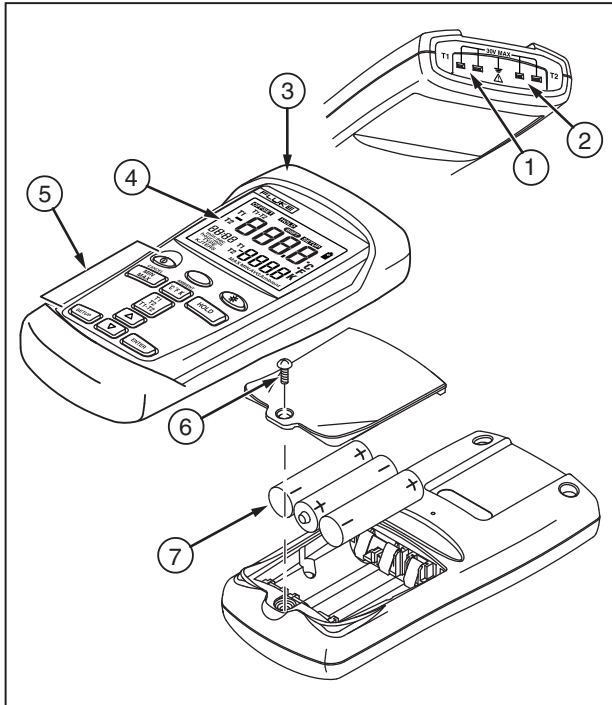

aas01f.eps

Figure 1. Components

Table 3. Components

①	Thermocouple T1 input
②	<i>Model 52:</i> Thermocouple T2 input
③	Holster
④	Display
⑤	Buttons
⑥	Battery door
⑦	Batteries

## Display Elements

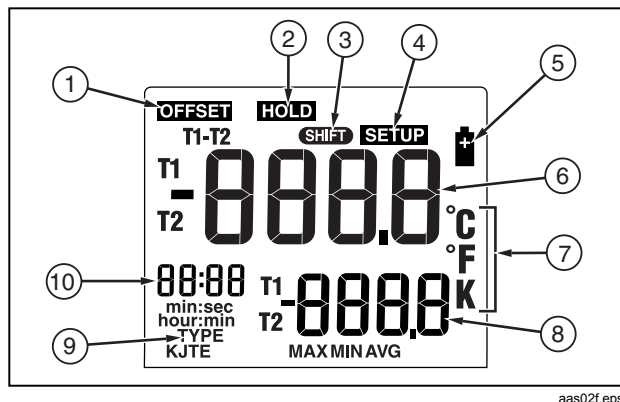



















Figure 2. Display Elements

Table 4. Display Elements











①	The thermocouple measurement includes an offset. See "Changing Setup Options."
②	The displayed readings do not change.
③	A shift function is in progress.
④	Setup is in progress.
⑤	Low battery. Replace the batteries.
⑥	Primary Display. <i>Model 51:</i> T1 reading. <i>Model 52:</i> T1, T2, or T1-T2 reading.
⑦	The temperature unit.
⑧	Secondary Display: MAX, MIN, AVG, or offset. <i>Model 52:</i> T1 or T2 reading.
⑨	The thermocouple type.
⑩	Time Display: The elapsed time.

**Buttons**

**Table 5. Buttons**

	<p>Press  to turn the thermometer on or off.</p>
 (Shift function)	<p>Press ,  (CANCEL) to stop displaying the minimum, maximum, and average readings in the secondary display.</p>
	<p>Press  to turn the backlight on and off. The backlight turns off after 2 minutes without any button presses. If the battery is low, the backlight is disabled.</p>
	<p>Press  to step through the maximum, minimum, and average readings. When viewing logged readings, shows the maximum, minimum, and average of the logged readings.</p> <p>Press ,  (CANCEL) to turn off this display.</p>
	<p>Press  to switch between Celsius (°C), Fahrenheit (°F), and Kelvin (K).</p>
	<p>Press  to freeze or unfreeze the displayed readings.</p> <p>Press  when turning on the thermometer to test the display. All display elements appear.</p>
	<p><i>Model 52:</i> Press  to toggle showing the T1, T2, and T1-T2 (differential temperature measurement) in the primary or secondary display.</p>

**Table 5. Buttons (cont.)**

	Press  to start or exit Setup. (See "Changing Setup Options.")
	Press  to scroll to the Setup option you want to change. Press  to increase the displayed setting.
	Press  to scroll to the Setup option you want to change. Press  to decrease the displayed setting.
	Press  to enter a Setup option. Press  again to store the displayed setting in memory.

## Using the Thermometer

1. Plug the thermocouple(s) into the input connector(s).
2. Press  to turn on the thermometer.

After 1 second the thermometer displays the first reading. If no thermocouple is plugged into the selected input or the thermocouple is "open," the display shows "- - -"

## Changing Setup Options

Use Setup to change the thermocouple type, offset, sleep mode, and line frequency settings.

The thermometer stores the settings in its memory. Setup settings reset only when the batteries are removed for more than 2 minutes.

## Entering or Exiting Setup







When the thermometer is in Setup mode, the display shows **SETUP**.

- Press  to start or exit Setup.

## Setup Options

Option	Menu Item	Settings
Thermocouple Type	<b>TYPE</b>	<b>J, K, T, or E</b>
Offset	<b>OFFSET</b>	<b>T1 or T2 (Model 52)</b>
Sleep Mode	<b>SLP</b>	<b>on</b> (sleep mode on) or <b>OFF</b> (sleep mode off)
Line Frequency	<b>LINE</b>	<b>50 H</b> (50 Hz) or <b>60 H</b> (60 Hz)

### **Changing a Setup Option**

1. Press  or  to scroll to the setup option you want to change.
2. Press  to indicate that you want to change this setting.
3. Press  or  until the setting you want to use appears on the display.
4. Press  to store the new setting in memory.

#### *Notes*

*Setup is disabled in MIN MAX mode.*

#### *Offset:*

*The primary display shows the temperature plus the offset and the secondary display shows the offset. Remember to reset the offset to 0.0 when it is no longer needed. The offset automatically resets to 0.0 when you change the thermocouple type. Model 52: You can store individual offsets for T1 and T2.*

#### *Sleep mode:*

*The thermometer enters sleep mode if no button press occurs for 20 minutes. Pressing any button wakes the thermometer and returns it to its previous state. Sleep mode becomes enabled each time you turn on the thermometer and is automatically disabled in MIN MAX mode.*

#### *Line frequency:*

*For optimum rejection of line noise, the thermometer must be set for the local line frequency.*

## Measuring Temperatures

### Connecting a Thermocouple

To change the thermocouple type, see “Changing Setup Options.” The North American ANSI Color Code is:

Type	J	K	E	T	N
Color	Black	Yellow	Purple	Blue	Orange

1. Plug a thermocouple into the input connector(s).  
(Make sure that the polarity is correct.)
2. Set the thermometer for the correct thermocouple type.

### Displaying Temperatures

1. Press **°C/F/K** to select the correct temperature scale.
2. Hold or attach the thermocouple(s) to the measurement location.

The temperature reading appears in the primary display.

3. *Model 52:* Press **T1  
T2  
T1-T2** to toggle between showing the T1, T2, and T1-T2 readings in the primary or secondary display.

### Notes

*The display shows "- - -" when a thermocouple is not connected.*



*The display shows **OL** (overload) when the temperature being measured is outside the thermocouple's valid range.*

*Model 52: If only thermocouple T2 is connected, the T2 reading appears in the primary display.*

### **Holding the Displayed Readings**

1. Press  to freeze the readings on the display.

The display shows **HOLD**.

2. *Model 52:* Press  to toggle showing the T1, T2, or T1-T2 readings in the primary or secondary display.
3. Press  again to turn off the HOLD function.

### **Viewing the MIN, MAX, and AVG Readings**

1. Press  to step through the maximum (MAX), minimum (MIN), or the average (AVG) readings.

The elapsed time since entering MIN MAX mode, or the time at which the minimum or maximum occurred, appears on the display.

2. Press ,  (CANCEL) to exit MIN MAX mode.

### **Using the Offset to Adjust for Probe Errors**

Use the offset option in Setup to adjust the thermometer's readings to compensate for the errors of a specific thermocouple.

The allowable adjustment range is  $\pm 5.0$  °C or K, and  $\pm 9.0$  °F.

1. Plug the thermocouple into the input connector.
2. Place the thermocouple in a known, stable temperature environment (such as an ice bath or a dry well calibrator).
3. Allow the readings to stabilize.
4. In Setup change the offset until the primary display reading matches the calibration temperature. (See "Changing Setup Options.")



## Maintenance

### Replacing the Batteries

Refer to the safety information in Table 1 before replacing the batteries.

1. Turn off the thermometer if necessary.
2. Loosen the screw and remove the battery door.
3. Replace the three AA batteries.
4. Replace the battery door and tighten the screw.

### Cleaning the Case and Holster

Use soap and water or a mild commercial cleaner.

Wipe with a damp sponge or soft rag.

## Calibration

To ensure that the thermometer performs to its accuracy specifications, Fluke recommends that you calibrate the thermometer annually, starting one year after purchase.

To calibrate the thermometer, contact Fluke for the Service Center nearest you or follow the calibration procedure in the service manual listed in "Replacement Parts and Accessories."

## Specifications

### Environmental

<b>Operating Temperature</b>	-10 °C to 50 °C (14 °F to 122 °F)
<b>Storage Temperature</b>	-40 °C to +60 °C (-40 °F to +140 °F)
<b>Humidity</b>	Non condensing <10 °C (<50 °F) 95 % RH: 10 °C to 30 °C (50 °F to 86 °F) 75 % RH: 30 °C to 40 °C (86 °F to 104 °F) 45 % RH: 40 °C to 50 °C (104 °F to 122 °F)

**General**

<b>Weight</b>	280 g (10 oz)
<b>Dimensions (without holster)</b>	2.8 cm × 7.8 cm × 16.2 cm (1.1 in × 3 in × 6.4 in)
<b>Battery</b>	3 AA batteries
<b>Certification</b>	CE, 
<b>Safety</b>	CAN/CSA C22.2 No. 61010-1-04, ANSI/UL 61010-1:2004, EN/IEC 61010-1:2001
<b>EMC</b>	EN/IEC 61326-1:2006
<b>CAT I</b>	OVERVOLTAGE (Installation) CATEGORY I, Pollution Degree 2 per IEC1010-1*
* Refers to the level of Impulse Withstand Voltage protection provided. Category 1 products should not be attached to mains circuits.	

**80 PK-1 Thermocouple (supplied with thermometer)**

<b>Type</b>	Type K, Chromel Alumel, bead style
<b>Temperature Range</b>	-40 °C to +260 °C (-40 °F to +500 °F)
<b>Accuracy</b>	± 1.1 °C (± 2.0 °F)

**Electrical**

<b>Measurement Range</b>	J-type: -210 °C to +1200 °C (-346 °F to + 2192 °F)  K-type: -200 °C to +1372 °C (-328 °F to +2501 °F)  T-type: -250 °C to +400 °C (-418 °F to +752 °F)  E-type: -150 °C to +1000 °C (-238 °F to +1832 °F)
<b>Display Resolution</b>	0.1 °C / °F / K <1000° 1.0 °C / °F / K ≥1000°

**Electrical (cont.)**

<b>Measurement Accuracy, T1, T2, or T1-T2 (Model 52)</b>	J-, K-, T-, and E-type: $\pm[0.05\% \text{ of reading} + 0.3\text{ }^\circ\text{C} (0.5\text{ }^\circ\text{F})]$ [below $-100\text{ }^\circ\text{C} (-148\text{ }^\circ\text{F})$ : add 0.15 % of reading for J-, K-, E-, and N-type; and 0.45 % of reading for T-type]
<b>Temperature Coefficient</b>	0.01 % of reading + 0.03 $^\circ\text{C}$ per $^\circ\text{C}$ (0.05 $^\circ\text{F}$ per $^\circ\text{F}$ ) outside the specified $+18\text{ }^\circ\text{C}$ to $28\text{ }^\circ\text{C}$ ( $+64\text{ }^\circ\text{F}$ to $+82\text{ }^\circ\text{F}$ ) range [below $-100\text{ }^\circ\text{C} (-148\text{ }^\circ\text{F})$ : add 0.04 % of reading for J-, K-, E-, and N-type; and 0.08 % of reading for T-type]
<b>Electromagnetic Compatibility</b>	Susceptibility: $\pm 2\text{ }^\circ\text{C}$ ( $\pm 3.6\text{ }^\circ\text{F}$ ) for 80 MHz to 200 MHz in 1.5 V/m field, for 200 MHz to 1000 MHz in 3 V/m field.  Emissions: Commercial Limits per EN50081-1
<b>Maximum Differential Common Mode Voltage</b>	1 V (Maximum voltage difference between T1 and T2)
<b>Temperature Scale</b>	ITS-90

<b>Applicable Standards</b>	NIST-175
Accuracy is specified for ambient temperatures between $18\text{ }^\circ\text{C}$ ( $64\text{ }^\circ\text{F}$ ) and $28\text{ }^\circ\text{C}$ ( $82\text{ }^\circ\text{F}$ ) for a period of 1 year. The above specifications do not include thermocouple error.	

**Replacement Parts and Accessories**

<b>Accessory</b>	<b>Part Number</b>
Holster and Flex Stand™ Assembly	1272438
AA NEDA 15A IEC LR6 batteries	376756
80PK-1 K-Type Bead Thermocouple	773135
CD-ROM	1276106
Service Manual	1276123



## Instrument Security Procedures

### Models:

Fluke 51, Fluke 52, Fluke 53 and Fluke 54 (and Series II and Series IIB)

### Product Name:

Digital Thermometers

### Instrument Description:

Fluke 50 Series II Contact Thermometers

Fluke 50 Series IIB Thermometers

### Memory Description:

The Fluke models 53 and 54 have three memory devices:

1. U11, EEPROM, Atmel AT25320, 4k x 8 bytes, non-volatile memory used to store logged readings.
2. U10, mask ROM micro controller, TI MSP430C337, contains operating code for the product.
3. U4, EEPROM, Atmel AT25010, 128 x 8 bytes, non-volatile memory used to store calibration constants.

The Fluke models 51 and 52 have two memory devices:

1. U10, mask ROM micro controller, TI MSP430C337, contains operating code for the product.
2. U4, EEPROM, Atmel AT25010, 128 x 8 bytes, non-volatile memory used to store calibration constants.

### Memory Cleaning Instructions:

The user can only access stored readings. Readings are cleared by using the front panel "clear memory" buttons.

# **51, 52, 53, 54 Series II**

Thermometer

## Service Manual

## LIMITED WARRANTY & LIMITATION OF LIABILITY

Each Fluke product is warranted to be free from defects in material and workmanship under normal use and service. The warranty period is three years and begins on the date of shipment. Parts, product repairs and services are warranted for 90 days. This warranty extends only to the original buyer or end-user customer of a Fluke authorized reseller, and does not apply to fuses, disposable batteries or to any product which, in Fluke's opinion, has been misused, altered, neglected or damaged by accident or abnormal conditions of operation or handling. Fluke warrants that software will operate substantially in accordance with its functional specifications for 90 days and that it has been properly recorded on non-defective media. Fluke does not warrant that software will be error free or operate without interruption.

Fluke authorized resellers shall extend this warranty on new and unused products to end-user customers only but have no authority to extend a greater or different warranty on behalf of Fluke. Warranty support is available if product is purchased through a Fluke authorized sales outlet or Buyer has paid the applicable international price. Fluke reserves the right to invoice Buyer for importation costs of repair/replacement parts when product purchased in one country is submitted for repair in another country.

Fluke's warranty obligation is limited, at Fluke's option, to refund of the purchase price, free of charge repair, or replacement of a defective product which is returned to a Fluke authorized service center within the warranty period.

To obtain warranty service, contact your nearest Fluke authorized service center or send the product, with a description of the difficulty, postage and insurance prepaid (FOB Destination), to the nearest Fluke authorized service center. Fluke assumes no risk for damage in transit. Following warranty repair, the product will be returned to Buyer, transportation prepaid (FOB Destination). If Fluke determines that the failure was caused by misuse, alteration, accident or abnormal condition of operation or handling, Fluke will provide an estimate of repair costs and obtain authorization before commencing the work. Following repair, the product will be returned to the Buyer transportation prepaid and the Buyer will be billed for the repair and return transportation charges (FOB Shipping Point).

THIS WARRANTY IS BUYER'S SOLE AND EXCLUSIVE REMEDY AND IS IN LIEU OF ALL OTHER WARRANTIES, EXPRESS OR IMPLIED, INCLUDING BUT NOT LIMITED TO ANY IMPLIED WARRANTY OF MERCHANTABILITY OR FITNESS FOR A PARTICULAR PURPOSE. FLUKE SHALL NOT BE LIABLE FOR ANY SPECIAL, INDIRECT, INCIDENTAL OR CONSEQUENTIAL DAMAGES OR LOSSES, INCLUDING LOSS OF DATA, WHETHER ARISING FROM BREACH OF WARRANTY OR BASED ON CONTRACT, TORT, RELIANCE OR ANY OTHER THEORY.

Since some countries or states do not allow limitation of the term of an implied warranty, or exclusion or limitation of incidental or consequential damages, the limitations and exclusions of this warranty may not apply to every buyer. If any provision of this Warranty is held invalid or unenforceable by a court of competent jurisdiction, such holding will not affect the validity or enforceability of any other provision.

Fluke Corporation  
P.O. Box 9090  
Everett WA 98206-9090  
U.S.A

Fluke Europe B.V.  
P.O. Box 1186  
5602 B.D.  
Eindhoven, The Netherlands

# Table of Contents

Title	Page
Introduction .....	1
Service Centers .....	2
International Symbols.....	2
Precautions and Safety Information .....	2
General Specifications .....	4
Environmental .....	4
Electrical .....	4
Performance Test and Calibration Required Test Equipment .....	5
Performance Tests .....	5
Display Test .....	5
Keypad Test .....	6
Wide Range Performance Test Procedure .....	6
Ice Bath Construction .....	6
Ice Bath Test .....	7
Verification of IR Communications Port (Fluke 53 and 54).....	8
Calibration and Offset Adjustment.....	9
A/D Calibration .....	9
Reference Junction Calibration .....	11
Using the Offset to Adjust for Variation Between Thermocouples .....	11
Basic Maintenance.....	12
Cleaning the Thermometer.....	12
Changing the Batteries .....	12
Disassembly and Reassembly.....	13
Disassembly .....	13
Reassembly .....	14
Reinstalling the LCD Assembly .....	14
Rebuilding the Main PCA.....	14
Reinstalling the Main PCA.....	15
Replaceable Parts.....	15

## Index





# ***List of Tables***

<b>Table</b>	<b>Title</b>	<b>Page</b>
1.	International Electrical Symbols Used in this Manual.....	2
2.	Recommended Test Equipment .....	5
3.	Performance Test Values (K-Type Thermocouple).....	8
4.	Replaceable Parts .....	15



# ***List of Figures***

<b>Figure</b>	<b>Title</b>	<b>Page</b>
1.	Display Segments .....	6
2.	Ice Bath Test Equipment Connections.....	7
3.	Calibration Connections .....	9
4.	Calibration Button Access .....	10
5.	Battery Access .....	13
6.	Exploded View (Model 54 is Shown).....	17



# **51, 52, 53, 54 Series II Service Manual**

## **⚠ Warning**

**To avoid shock or injury, do not perform the performance tests or calibration procedures described in this manual unless you are qualified to do so.**

**Refer to the Safety Information section of this manual before using the Fluke 51, 52, 53, 54 Series II Thermometers.**

## **Caution**

**The Fluke 51, 52, 53, 54 Series II Thermometers contain parts that can be damaged by static discharge.**

**Follow the standard practices for handling static sensitive devices.**

## ***Introduction***

This manual provides the following service information for the 51, 52, 53, and 54 Series II Thermometers, hereafter referred to as “the thermometer”.

- Precautions and safety information
- Specifications
- Performance tests
- Calibration and adjustment
- Basic maintenance
- Replaceable parts

For complete operating instructions, refer to the *51/52 Series II Users Manual* or the *53, 54 Series II Users Manual*, located on the *51/54 Series II CD ROM*, part number 1276106.

## Service Centers

To contact Fluke, order parts, or locate a Fluke service center, call one of the following telephone numbers:





USA: 1-888-99-FLUKE (1-888-993-5853)  
Canada: 1-800-36-FLUKE (1-800-363-5853)  
Europe: +31 402-678-200  
Japan: +81-3-3434-0181  
Singapore: +65-738-5655  
Anywhere in the world: +1-425-446-5500

Or, visit Fluke's Web site at [www.fluke.com](http://www.fluke.com).

## International Symbols

Table 1 identifies the international electrical symbols used in this manual.

Table 1. International Electrical Symbols Used in this Manual

	Low Battery		Important information
	Complies with relevant Canadian Standards Association directives		Complies with European Union directives

## Precautions and Safety Information

Use the thermometer only in the ways specified in the *51/52 Series II Users Manual and the 53/54 Series II Users Manual*. If the thermometer is used in ways not specified, the thermometer may be damaged.

In this manual, a **Warning** statement identifies conditions and actions that pose a hazard to the user; a **Caution** statement identifies conditions and actions that may damage the thermometer or the test instruments.

## Safety Information

### **⚠ Warning**

To avoid electrical shock or personal injury, follow these guidelines:

- Before using the thermometer, inspect the case. Do not use the thermometer if it appears damaged. Look for cracks or missing plastic. Pay particular attention to the insulation around the connectors.
- Disconnect the thermocouple(s) from the thermometer before opening the case.
- Replace the batteries as soon as the low battery indicator (⚡) appears. The possibility of false readings can lead to personal injury.
- Do not use the thermometer if it operates abnormally. Protection may be impaired. When in doubt, have the thermometer serviced.
- Do not operate the thermometer around explosive gas, vapor, or dust.
- Do not apply more than the rated voltage, as marked on the thermometer, between the thermocouple(s), or between any thermocouple and earth ground.
- Models 52 and 54: Measurement errors may occur if voltages on the measurement surfaces result in potentials greater than 1 V between the two thermocouples. When potential differences are anticipated between the thermocouples, use electrically insulated thermocouples.
- When servicing the thermometer, use only specified replacement parts.
- Do not use the thermometer with any part of the case or cover removed.

### **Caution**

To avoid damaging the thermometer or the equipment under test:

- Use the proper thermocouples, function, and range for your thermometer.
- Do not attempt to recharge the batteries.
- To prevent explosion, do not dispose of batteries in fire.
- Follow local laws or regulations when disposing of batteries.
- Match the + and – polarities of the batteries with the battery case markings.



## Specifications

### General Specifications

Weight	280 g (10 oz)
Dimensions (without holster)	2.8 cm × 7.8 cm × 16.2 cm (1.1 in × 3 in × 6.4 in)
Battery	3 AA batteries
Certification	CE,  (TÜV pending)
Safety	CSA C22.2 No. 1010.1 1992 EN 61010 Amendments 1, 2
CAT I	OVERVOLTAGE (Installation) CATEGORY I, Pollution Degree 2 per IEC1010-1*
* Refers to the level of Impulse Withstand Voltage protection provided. Equipment of OVERVOLTAGE CATEGORY I is equipment for connection to circuits in which measures are taken to limit the transient over voltages to an appropriate low level.	

### Environmental

Operating Temperature	-10 °C to +50 °C (+14 °F to +122 °F)
Storage Temperature	-40 °C to +60 °C (-40 °F to +140 °F)
Humidity	Non Condensing (< +10 °C) (< +50 °F) 95% RH (+10 °C to +30 °C) (+50 °F to +86 °F) 75% RH (+30 °C to +40 °C) (+86 °F to +104 °F) 45% RH (+40 °C to +50 °C) (+104 °F to +122 °F) (Without Condensation)

### Electrical

Measurement Range	J-type: -210 °C to +1200 °C (-346 °F to +2192 °F) K-type: -200 °C to +1372 °C (-328 °F to +2501 °F) T-type: -250 °C to +400 °C (-418 °F to +752 °F) E-type: -150 °C to +1000 °C (-238 °F to +1832 °F) N-type: -200 °C to +1300 °C (-328 °F to +2372 °F) R- and S-type: 0 °C to +1767 °C (+32 °F to +3212 °F)
Display Resolution	0.1 °C / °F / K < 1000° 1.0 °C / °F / K ≥ 1000°
Measurement Accuracy	J-, K-, T-, E-, and N-type: ±[0.05 % of reading + 0.3 °C (0.5 °F)] [below -100 °C (-148 °F): add 0.15 % of reading for J, K, E, and N; and 0.45 % of reading for T] R- and S-type: ±[0.05 % of reading + 0.4 °C (+0.7 °F)]
Temperature Coefficient	0.01 % of reading + 0.03 °C per °C (0.05 °F per °F) outside the specified +18 °C to +28 °C (+64 °F to +82 °F) range [below -100 °C (-148 °F): add 0.04 % of reading for J-, K-, E-, and N-type; and 0.08 % of reading for T-type]
Electromagnetic Compatibility	Susceptibility: ± 2 °C (± 3.6 °F) for 80 MHz to 200 MHz in 1.5 v/m field, for 200 MHz to 1000 MHz in 3 V/m field. Emissions: Commercial limits per EN50081-1
Maximum Differential Common Mode Voltage	1 V (Maximum voltage difference between T1 and T2)
Temperature Scale	ITS-90
Applicable Standards	NIST-175
Accuracy is specified for ambient temperatures between +18 °C (+64 °F) and +28 °C (+82 °F) for a period of 1 year. The above specifications do not include thermocouple error.	

## Performance Test and Calibration Required Test Equipment

Refer to Table 2 for a list of test equipment used in the performance test and calibration procedures.

**Table 2. Recommended Test Equipment**

Equipment	Required Characteristics	Recommended Model
DC Voltage Calibrator	Output Voltage: 0-1V Accuracy: 0.0125 % Resolution: 0.1 $\mu$ V	Fluke 5700A or equivalent
Thermocouple connector	For K-type thermocouple	Fluke 80CK-M Fluke P/N 779942
Thermocouple connector	Copper	Fluke P/N 601747
K-type Thermocouple wire	Standard	Omega
Dewar Flask/Cap	1- pint, or larger capacity	Thermos
Mercury Thermometer (either °C or °F)	0.02 °C Resolution 0.05 °F Resolution	Princo Model ASTM56C Princo Model ASTM56F
DB9 Adapter Connector		Fluke P/N 804549
IR Adapter		Fluke P/N 690518
PC with Microsoft Windows® installed		

### Performance Tests

Performance tests are recommended for incoming inspection, periodic maintenance, and for checking the thermometer's specifications. If the thermometer fails any part of the performance tests, calibration and/or repair is indicated.

Before performing these tests:

1. Allow the thermometer to stabilize to room temperature,  $+23\text{ }^{\circ}\text{C} \pm 5\text{ }^{\circ}\text{C}$  ( $+73\text{ }^{\circ}\text{F} \pm 9\text{ }^{\circ}\text{F}$ ).
2. Check the batteries and replace them if necessary.

### Display Test

Turn the thermometer on while pressing the HOLD button. All display segments are displayed until the HOLD button is released. Confirm that all the display segments are showing as in Figure 1.

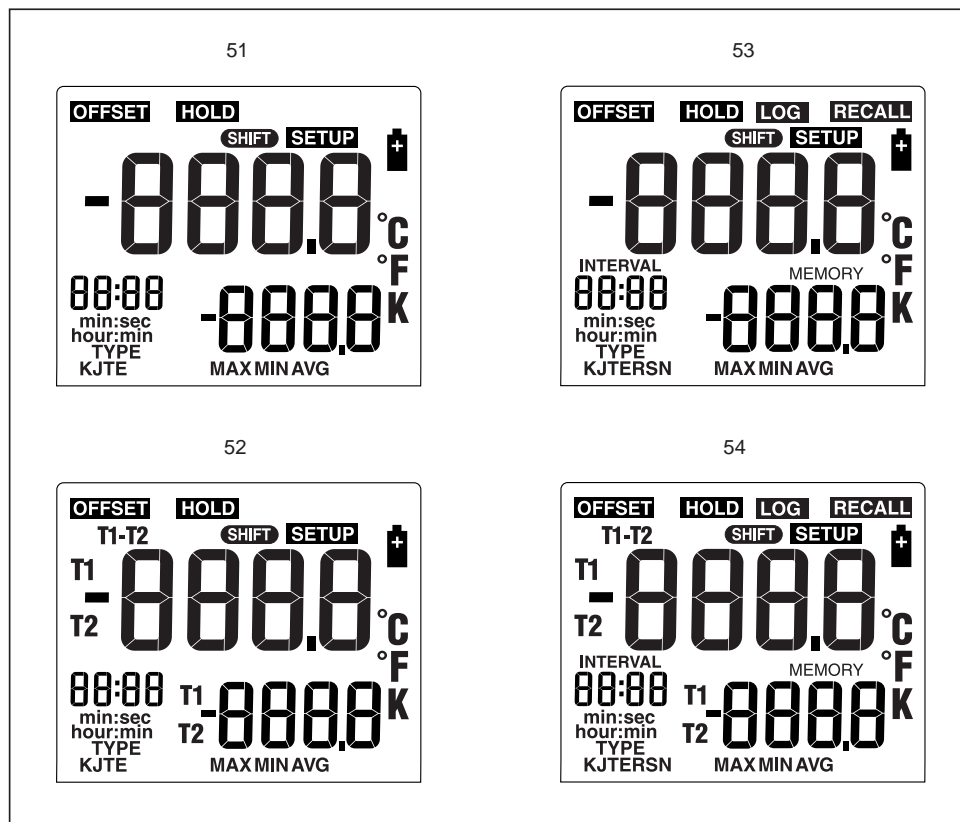

Figure 1. Display Segments

zb03f.eps

### Keypad Test

Check that all keypad switches are functional by pressing each key and confirming the proper response on the display.

### Wide Range Performance Test Procedure

This test verifies the instrument specifications. If the instrument fails this test, perform the calibration procedure. If the unit continues to fail, it should be taken to a Fluke service center.

### Ice Bath Construction

To begin the performance test, first construct an ice bath as follows:

1. Prepare a Dewar Flask by drilling two holes in its cap to accept the Mercury thermometer and thermocouple wires, or use a standard laboratory cork.
2. Fill the Dewar Flask with shaved or crushed ice made from distilled water.
3. Fill the Dewar Flask with enough distilled water so that the ice turns to slush, but do not add enough water to float the ice.

#### Note

*As the ice melts, siphon off the excess water and add more ice. Allow approximately 5 to 10 minutes for the water to drop back to the freezing point.*

- Replace the Dewar Flask cap or cork, and insert the thermocouple wires and Mercury thermometer as shown in Figure 2. Insert the Mercury thermometer to the same depth as the thermocouple wire.

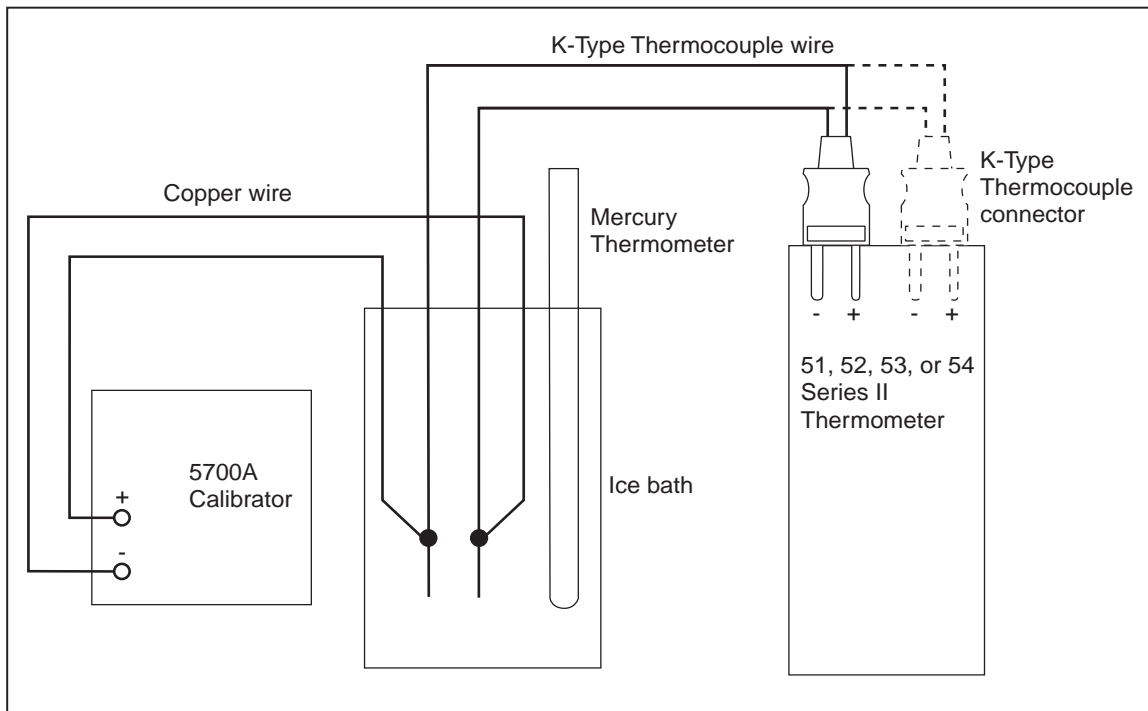

**Figure 2. Ice Bath Test Equipment Connections**

zb04f.eps

### Ice Bath Test

Use the following procedure to test the thermometer. If the thermometer has two inputs, this test should be conducted on both thermocouple inputs.

- If not already selected, select K-type thermocouple on the thermometer using the **SETUP**, **▲**, **▼**, and **ENTER** buttons.
- Connect the equipment as shown in Figure 2. Allow the setup to thermally stabilize at least 5 minutes after inserting the thermocouple into the thermometer.
- Verify that the ice bath temperature reads  $0.0\text{ }^{\circ}\text{C} \pm 0.06\text{ }^{\circ}\text{C}$  on the Mercury thermometer.
- Short (or apply  $0\text{ mV}$ ) to the copper wires at the Calibrator.
- Verify the thermometer reads  $0.0\text{ }^{\circ}\text{C} \pm 0.3\text{ }^{\circ}\text{C}$ .
- If this test fails, reposition the thermocouple wires and Mercury thermometer to the same depth in the ice bath, and repeat steps 3-5. If the test continues to fail, perform the calibration procedure, located after this procedure.
- Remove the short applied in step 4.
- Using Table 3, steps 2-5, obtain an output from the Calibrator equal to the values in the "Input Voltage (mV DC)" column, and verify the thermometer reads within the limits specified. If any step fails, perform the calibration procedure located later in this section.
- Disconnect the thermocouple from the input terminals. This completes the ice bath test.

Table 3. Performance Test Values (K-Type Thermocouple)

Step	Input Voltage (mV DC)	Equivalent Temperature		Display Reading limits	
				°C	°F
1	0.0000	0.0 °C	32.0 °F	-0.3 to 0.3	31.5 to 32.5
2	0.9193	23.0 °C	73.4 °F	22.7 to 23.3	72.9 to 73.9
3	-5.7297	-190.0 °C	-310.0 °F	-189.3 to -190.7	-308.9 to -311.1
4	40.8853	990.0 °C	1814 °F	989.2 to 990.8	1813 to 1815
5	48.8382	1200 °C	2192 °F	1199 to 1201	2190 to 2194

### Verification of IR Communications Port (Fluke 53 and 54)

This section explains how to verify the operation of the IR Communications Port (IR port). Perform the following procedure using a PC and HyperTerminal. The IR port can also be verified using Flukeview™ software.

To set up a HyperTerminal file, follow these steps:

1. Connect the IR adapter cable to the DB9 Adapter connector. Connect the other end of the DB9 Adapter to a COM port of the PC.
2. Place the Fluke 53 or 54 in front of the IR adapter.
3. Open up a HyperTerminal session. Select **Start button, Programs, Accessories, HyperTerminal**.
4. Open up a **New Connection** with a name like "Fluke 54 IR Test".
5. When the **Connect To** box appears, select the COM1 or COM2 (the port that the IR adapter cable is plugged into).
6. Select **Port Settings**: 9600 baud rate, 8 data bits, no parity, 1 stop bit, and no flow control.
7. Under **File**, select **properties**. Verify that the correct port is selected. Click on **Configure**. Verify that port settings are correct (the baud rate may need to be changed to 9600).
8. Select the **Settings** tab then click on **ASCII Setup**. Check the following boxes:
  - Echo typed characters locally
  - Append line feeds to incoming line ends
  - Wrap lines that exceed terminal width

To open a HyperTerminal file to test the IR port, use the following procedure:

1. Under **File**, select **Save As**. Use a file name such as "Fluke 54 IR Test" and then click on **save**.
2. Click on the **phone disconnect** icon.
3. Click on **open folder** or under **File** select **Open**. Double click on Fluke 54 IR Test.
4. Type in "ID" followed by the **Enter** key (notice the "ID" is capitalized).
5. The display of the thermometer now shows the thermometer name (Fluke 53-II or Fluke 54-II), and the units operating software version (e.g. Fluke 54-II, V1.01).

## Calibration and Offset Adjustment

Calibration consists of two parts:

1. Calibration of the A/D converter, using the set up shown in Figure 3.
2. Reference junction calibration, using the ice bath test set up shown in Figure 2.

### A/D Calibration

To calibrate the A/D portion of the thermometer, follow these steps:

1. Connect the calibrator to the T1 input of the thermometer using copper (non-thermocouple) wire and a copper thermocouple connector. Refer to Figure 3 for proper equipment connections.
2. Turn the thermometer on, with a small, blunt probe, press the calibration button located on the back and in the center of the thermometer. Refer to Figure 4.

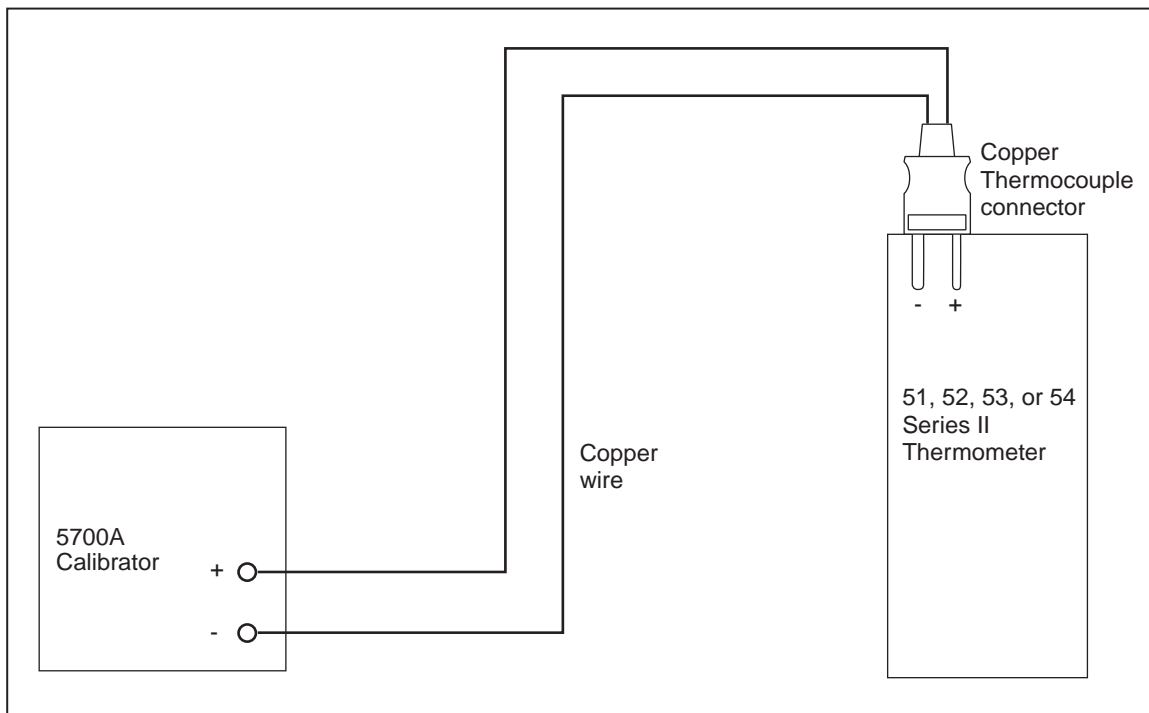

Figure 3. Calibration Connections

zb06f.eps

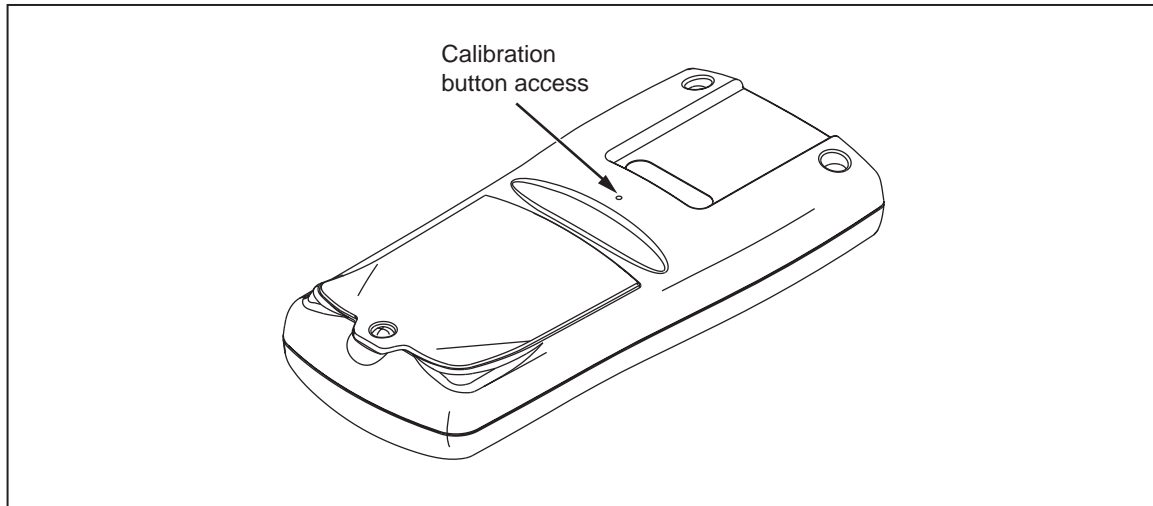

Figure 4. Calibration Button Access

zb02f.eps

3. The menu on the display changes to “**CAL A-d**”.

*Note*

Within **CAL** are four menu options that may be accessed by pressing .

- **CAL A-d** prompts the operator for the A/D calibration inputs in mV dc.
  - **CAL rEF** allows the operator to calibrate the reference junction at a known temperature.
  - **CAL donE** saves the new calibration constants in memory.
  - **CAL Abrt** ignores calibration changes (turning the thermometer off while in **CAL** will also ignore calibration changes).
4. Press  or  to select different menu options.
  5. With **CAL A-d** selected, press . The thermometer prompts “80”. Set the calibrator to +80.000 mV and allow the output to stabilize.

*Note*

For steps 6 and 8, keep hand and body motion to a minimum while the thermometer takes A/D readings.

6. Press . Wait while it takes A/D readings.
7. When the thermometer prompts for “-8”, set the Calibrator to -8.0000 mV. Allow the output to stabilize.
8. Press  on the thermometer and wait while it takes A/D readings. The thermometer now shows the measured value in the bottom portion of the display. Millivolts appears on the left side and microvolts appears on the right side.
9. If the measurement is from -7 995.0 to -8 005.0, press  and the meter will return to the calibration menu and display **CAL rEF**. If the measurement is outside -7995.0 to -8005.0, press  once to return to the calibration menu. Using  or , select **CAL A-d** and try the A/D calibration procedure a second time starting at step 5.
10. Using  or , select “**CAL donE**”, then press  to store the calibration in memory.

11. To ignore the calibration changes, use  or , and select “**CAL Abrt**” and press .
12. Proceed to Reference Junction Calibration.

### **Reference Junction Calibration**

*Note*

*This procedure is described using an ice bath and a K-type thermocouple. It can be performed in °C, °F, or K with any thermocouple and a known, accurate temperature between 0 °C (+32 °F) and +50 °C (+122 °F).*

*Note*

*It is important that the temperature of the thermocouple and the internal temperature of the thermometer (the reference junction) have stabilized.*

To calibrate the reference junction, follow these steps:

1. Prepare an ice bath (described earlier in this section).
2. Referring to Figure 2, connect the equipment to T1 using K-type thermocouple wire and a K-type thermocouple connector. Allow the setup to thermally stabilize at least 5 minutes after inserting the thermocouple connector into the thermometer.
3. Turn the thermometer on and select the thermocouple type using the , , , and  buttons.
4. Enter calibration mode (refer to the “A/D Calibration” section, step 2).
5. Using  or , select **CAL rEF** and press .
6. Press  or  until the upper display matches the known temperature.

*Note*

*Once adjusted, do not change units (°C, °F, or K) until the thermometer is in measurement mode.*

7. Press the  button.
8. “**CAL done**” appears then press  to store the calibration in memory.
9. To ignore the calibration changes, use the  or , and select “**CAL Abrt**” and press .

### **Using the Offset to Adjust for Variation Between Thermocouples**

Use the offset option in the thermometer SETUP mode to adjust the thermometer's readings for errors of a specific thermocouple. Use the following procedure:

1. Plug the thermocouple into the thermometer input then allow the setup to thermally stabilize at least 5 minutes.
2. Place the thermocouple in a known, stable temperature environment (such as an ice bath, lag bath, or a dry well calibrator).
3. Allow the readings to stabilize.
4. In SETUP, change the offset until the primary display reading matches the bath temperature. (See “Changing Setup Options” in the *51/52 Series II Users Manual*, and the *53/54 Series II Users Manual*.)



## **Basic Maintenance**

Basic maintenance required by the thermometer is discussed in this section.

### ***Cleaning the Thermometer***

#### **Caution**

- **To avoid damaging the thermometer, do not use aromatic hydrocarbons or chlorinated solvents for cleaning. These solutions react with the plastics used in the thermometer.**
- **Do not allow the LCD to get wet.**
- **Do not remove any of the lubricant from the battery/pca connection.**

Clean the thermometer case with a mild detergent and water.

The pca may be washed with isopropyl alcohol or deionized water and a soft brush. Dry the pca with clean dry air at low pressure, then bake it at +50 °C (+122 °F) for 24 hours.

### ***Changing the Batteries***

#### **⚠ Warning**

- **Replace the batteries as soon as the low battery indicator (⚡) appears. The possibility of false readings increases when the batteries are low. False readings can lead to personal injury.**
- **To avoid electrical shock, disconnect the thermocouple(s) before opening the battery door.**

#### **Caution**

- **Do not attempt to recharge the batteries.**
- **Do not dispose of the batteries by placing them in fire.**
- **Follow local laws or regulations when disposing of batteries.**
- **Match the positive (+) and negative (-) polarities of the batteries with the markings located on the case.**

To replace the batteries, refer to Figure 5 and use the following procedure:

1. Turn the thermometer off.
2. Loosen the battery compartment door screw and remove the battery door.
3. Replace the three AA batteries. To simplify battery installation, put the new batteries into the unit positive end first.
4. Replace the battery compartment door and tighten the screw.

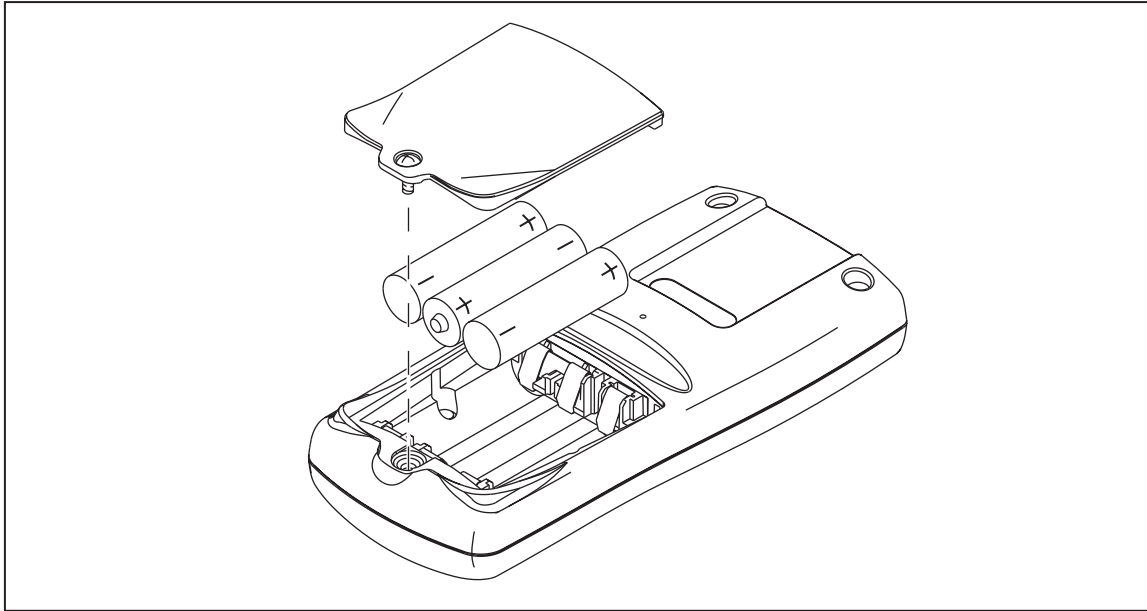

Figure 5. Battery Access

zb01f.eps

## ***Disassembly and Reassembly***

Disassembly and reassembly of the thermometer may be necessary to replace interior parts. Refer to Figure 6 when disassembling and reassembling the thermometer.

### ***Disassembly***

To disassemble the thermometer, follow these steps:

1. Remove the batteries (see “Changing the Batteries” section).
2. Remove the two screws located inside the battery compartment.

#### **Caution**

- **Before proceeding, make sure that you are grounded to prevent static discharge, which could damage the thermometer.**
  - **Inside the unit there are parts that can become contaminated by oils from the skin. These parts should not be directly handled. When lifting out the elastomeric connectors and the main switch pad, it is recommended that tweezers or sterile gloves be used.**
3. Remove the two case bottom screws, located at the LCD-end of the unit and separate the bottom case from the top case.
  4. Removing any of the interior components of the unit requires removing the Main PCA. To remove the Main PCA, place the top case face down and remove the two screws that attach the Main PCA to the top case. Gently lift the Main PCA out of the top case. The IR Lens, small Isothermal PCA, backlight, elastomeric connectors, and the LCD may all lift out attached to the Main PCA.
  5. If the Isothermal PCA separates from the Main PCA, the Isothermal PCA, IR Lens, backlight, elastomeric connectors, and the LCD will still be in the top case. Lift them out of the top case after the Main PCA is removed.

6. The LCD decal is now exposed and may be removed.
7. To remove the main switch pad, first remove the small elastomeric connector at the top of the switch pad, and then lift out the entire switch pad.

### **Reassembly**

The reassembly procedure is basically the reverse of the disassembly procedure. However, there are several points in this process that should be explained further.

#### *Note*

*For reassembly, the thermometer top case should be face down, with the keypad end of the top case facing the user.*

### **Reinstalling the LCD Assembly**

Follow these steps to reinstall the LCD assembly:

1. Install the LCD decal.
2. When putting the LCD back into the top case, make sure the LCD is correctly aligned. The edge of the LCD with the bubble in it should be facing the left side of the open, face down top case, and the LCD should be placed into the top case face down.
3. When reinstalling the backlight, the backlight pins should be on the left side of the open top case and they should be facing up. Check that the pins are straight. To make sure that the backlight is centered, line up the bottom left corner of the backlight with the guide that is molded into the top case. The left corner of the backlight should fit directly over this guide and the bottom right side of the backlight should also be lined up with (but not over) a similar guide on the right side of the open top case.
4. Install the two LCD elastomeric connectors.

### **Rebuilding the Main PCA**

When reinstalling the Main PCA, make sure that the Isothermal PCA and the IR Lens are attached to each other first. To do this, follow these directions:

1. Turn the Main PCA over so that the components are face down.
2. Attach the Isothermal PCA to the Main PCA by inserting the pins into the matching holes on the Main PCA.

#### *Note*

*When putting the Isothermal PCA back onto the Main PCA, do not push the Isothermal PCA all the way down into the contact holes of the Main PCA. If the Isothermal PCA is kept slightly loose, it makes installation of the IR Lens easier.*

3. Reinstall the IR Lens by taking the Main PCA (with the Isothermal PCA loosely attached), and with the component side facing down; slide the IR Lens in between the main board and the Isothermal PCA.
4. Line up the tab on the Isothermal PCA and the notch in the IR Lens and push the two together. The contacts of the IR Lens should slide under the Isothermal PCA and they should be making contact with pads on the underside of the Isothermal PCA.

5. Push the Isothermal PCA and the Main PCA together so that the Isothermal PCA pins go deeper into the Main PCA sockets. This holds the IR Lens in place and allows the Main PCA to be reinstalled into the top case.

### *Reinstalling the Main PCA*

1. While holding the IR Lens to the Main PCA, turn the Main PCA over so that the components are facing up.
2. Align the screw holes in the Main PCA with those in the top case.
3. Align the backlight pins with the Main PCA sockets.
4. Align the Main PCA holes with the backlight posts.
5. Gently push the Main PCA down into the top case, making sure that the IR Lens goes into the groove on the LCD-end of the top case. If it does not fit together easily, check to make sure that everything is properly lined up and try again.
6. Reinsert and tighten the two pca screws.

To complete the thermometer reassembly, screw the bottom case to the top case, reinstall the batteries and screw the battery compartment shut.

## **Replaceable Parts**

Refer to Table 4 for all replacement part numbers and Figure 6 for part locations. Unless specified in the “Model Number” column, all parts are for all units. To order replaceable parts, see the “Service Centers” section of this manual.

**Table 4. Replaceable Parts**

Item Number	Qty.	Fluke Part Number	Description	Model Number
1	3	376756	BATTERY, PRIMARY, 1.5V, 0-150MA, AA ALKALINE	All
2	4	803582	SCREW, PH, P, CAPT, STL, 4-40, .25	All
3	1	642931	BATTERY DOOR: <ul style="list-style-type: none"> <li>• SCREW, PH, P, AM THD FORM, STL, 4-14, .312</li> <li>• DOOR, BATTERY</li> </ul>	All
4	1	669838		All
5	1	669812 669804 669801 669796	CASE, TOP CASE, TOP CASE, TOP CASE, TOP	51 52 53 54
6	1	1541901	ISOTHERMAL PCA (TESTED)	All
7	2	804713	CONNECTOR, ELASTOMERIC, LCD TO PWB, 2.210 L	All
8A-F	1	1541895	BOTTOM CASE ASSEMBLY  Bottom Case Assembly contains:	All
8A	2	666435	<ul style="list-style-type: none"> <li>• BATTERY CONTACT, DUAL</li> </ul>	All
8B	1	674744	<ul style="list-style-type: none"> <li>• BATTERY CONTACT (POS)</li> </ul>	All
8C	1	674770	<ul style="list-style-type: none"> <li>• BATTERY CONTACT (NEG)</li> </ul>	All
8D	1	669819	<ul style="list-style-type: none"> <li>• CASE, BOTTOM</li> </ul>	All
8E	1	658689	<ul style="list-style-type: none"> <li>• KEYPAD, CALIBRATION</li> </ul>	All
8F	1	675009	<ul style="list-style-type: none"> <li>• SHIELD</li> </ul>	All

**Table 4. Replaceable Parts (cont.)**

<b>Item Number</b>	<b>Qty.</b>	<b>Fluke Part Number</b>	<b>Description</b>	<b>Model Number</b>
9A-B	1	1541912	51/53 SERIES II IR LENS KIT	51, 53
	1	1543462	52/54 SERIES II IR LENS KIT	52, 54
			IR Lens Kit contains:	
9A	2	—	• SPRING, ISOTHERMAL	51, 53
	4			52, 54
9B	1	—	• IR LENS	51, 53
	1		• IR LENS	52, 54
10	1	675017	WINDOW, PROTECTOR	All
11	1	675030	LCD DECAL	51
		675025	LCD DECAL	52
		675022	LCD DECAL	53
		675014	LCD DECAL	54
12	1	674747	BACKLIGHT	All
13	1	1272438	HOLSTER & FLEX STAND ASSEMBLY	All
14	2	643830	SCREW, PH, P, METRIC PT, STL, K35, 14MM	All
15	1	669793	KEYPAD	51
		669788	KEYPAD	52
		669785	KEYPAD	53
		669777	KEYPAD	54
16	1	804705	CONNECTOR, ELASTOMERIC, SWITCH TO PWB, 1.200 L	All
17	1	800836	LCD, MULTIPLEXED	All
Not shown	1	1276106	CD ROM, CD ROM FLUKE 50 SERIES II	All
			CD ROM contains:	
			• 51/52 Series II Users Manual (16 Languages)	
			• 53/54 Series II Users Manual (16 Languages)	
Not shown	1	1276114	FLUKE 51-54 SERIES II PRODUCT OVERVIEW	All
Not shown	1	773135	THERMOCOUPLE ASSY, T/C ASSY, K-TYPE, BEADED, MOLDED-PLUG	51, 53
	2			52, 54

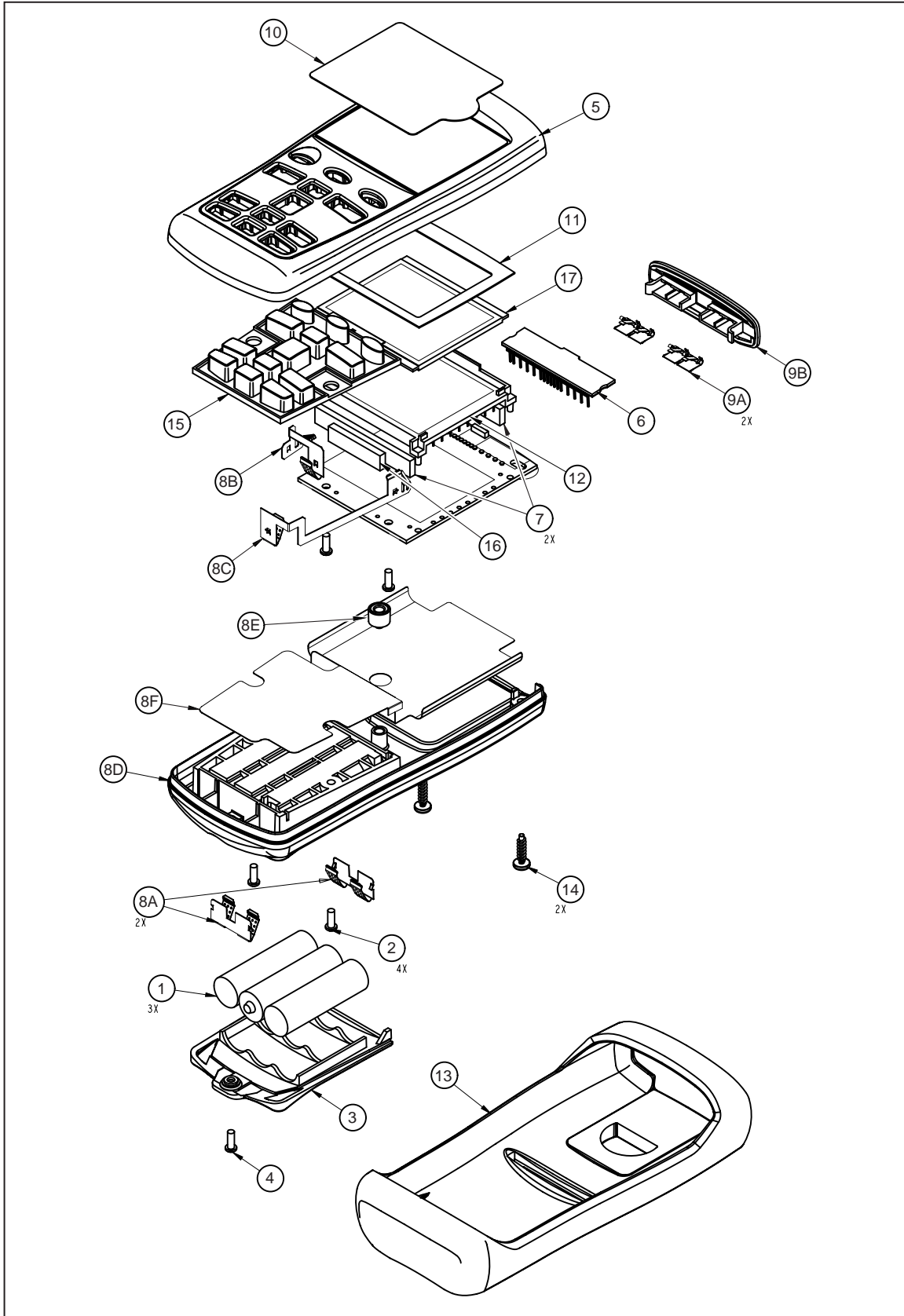

Figure 6. Exploded View (Model 54 is Shown)

zb07f.eps



# Index

## —A—

assembly, 13

## —B—

batteries

- access to, 13
- changing, 12

## —C—

calibration, 9

- A/D, 9
- A/D connections, 9
- button access, 10
- CAL Abrt, 10
- CAL A-d, 10
- CAL donE, 10
- CAL rEF, 10
- offset, 9
- reference junction, 11
- variations between thermocouples, 11

caution, 12, 13

CD ROM, 1

## —D—

disassembly, 13

display

- segments, 6

## —E—

electrical symbols, 2

## —H—

HyperTerminal, 8

## —I—

ice bath

- construction, 6
- equipment connections, 7
- test, 7

## —L—

LCD

- reinstalling, 14

## —M—

Main PCA

- rebuilding, 14
- reinstalling, 15

maintenance

- basic, 12
- batteries, changing, 12
- cleaning, 12

## —P—

parts

- diagram, 17
- list of replaceable, 15

performance tests, 5

display test, 5

IR communications port verification, 8

keypad test, 6

test values, k-type thermocouple, 8

wide range, 6

precautions, 2

## —R—

reassembly, 14



**—S—**

safety, 2  
cautions and warnings, 3  
service centers  
  phone numbers, world wide web address, 2  
specifications  
  electrical, 4  
  environmental, 4  
  general, 4

**—T—**

test equipment

performance testing and calibration, 5

**—U—**

Users Manual  
  51, 52 Series II, 1  
  53, 54 Series II, 1

**—W—**

warnings, 1, 12

# Manual Supplement

Manual Title:	51,52,53,54 Series II Service	Supplement Issue:	2
Part Number:	1276123	Issue Date:	6/05
Print Date:	October 1999	Page Count:	1
Revision/Date:			

---

---

This supplement contains information necessary to ensure the accuracy of the above manual. Enter the corrections in the manual if either one of the following conditions exist:

1. The revision letter stamped on the indicated PCA is equal to or higher than that given with each change.
2. No revision letter is indicated at the beginning of the change.

## Change #1

On page 8, under **Verification of IR Communications Port (Fluke 53 and 54)**, add step 3A as follows:

- 3A. On the Fluke 53 or 54, press  then **RECALL**.

## Change #2

On page 8, Table 3, replace steps 4 and 5 with the following:

Step	Input Voltage (MV DC)	Equivalent Temperature		Display Reading Limits	
4	40.8853	990.0 °C		989.2 to 990.8	
5	48.8382		2192 °F		2190 to 2194